

Mazel micro:bit

Věčně nespokojená ovečka



Žijeme v době, kdy máme řešení nebo dokonce chytrou aplikaci skoro na všechno. To bohužel příliš nemotivuje k hledání a vynalézání nových řešení!

V HW Kitchen se snažíme to změnit a znovu probudit v lidech jejich přirozenou představivost a tvořivost.

Stavebnice micro:bit vám přinesou spoustu zábavy, naučíte se s nimi základy programování, ale hlavně jak tvořit věci, o kterých jste předtím třeba jen snili!



WWW.HWKITCHEN.CZ

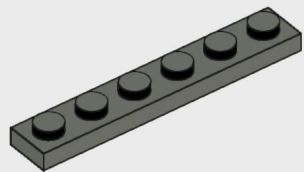

1x
3666, 85

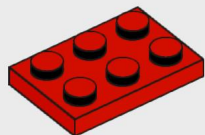

1x
3021, 5



6x
85861, 88

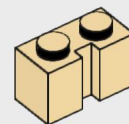

6x
4216, 2

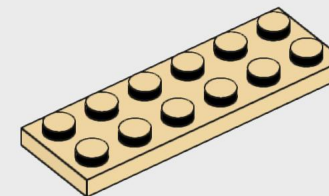

2x
3795, 2

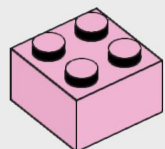

1x
3003, 104

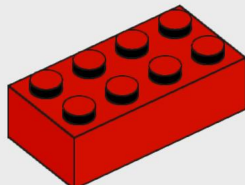

10x
3001, 5

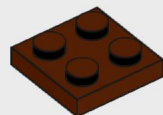

1x
3022, 88

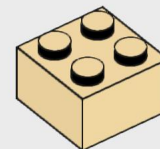

6x
3003, 2

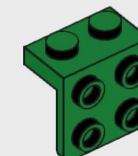

3x
44728, 6

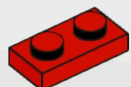

1x
3023, 5

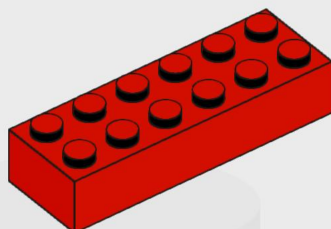

5x
2456, 5

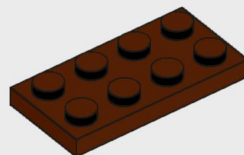

2x
3020, 88

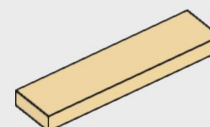

1x
2431, 2



7x
87580, 5

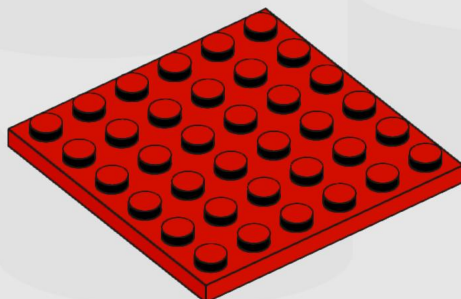

1x
3958, 5

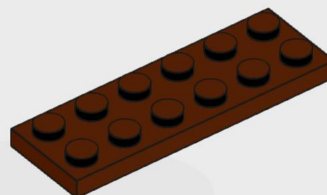

1x
3795, 88

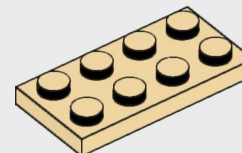

2x
3020, 2

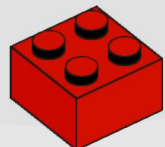

8x
3003, 5

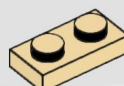

2x
3023, 2

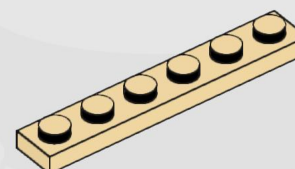

1x
3666, 2

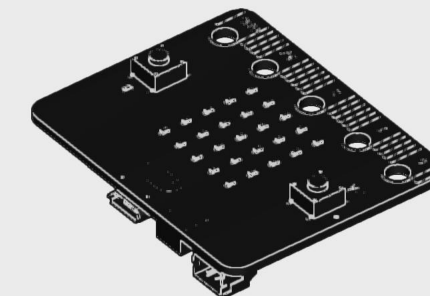

1x



všechny neelektronické součástky naleznete například ve stavebnici LEGO Minecraft 21153



1

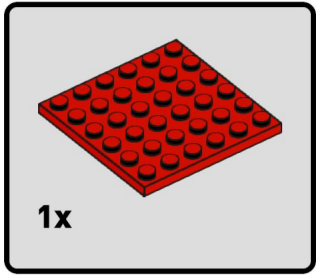

2

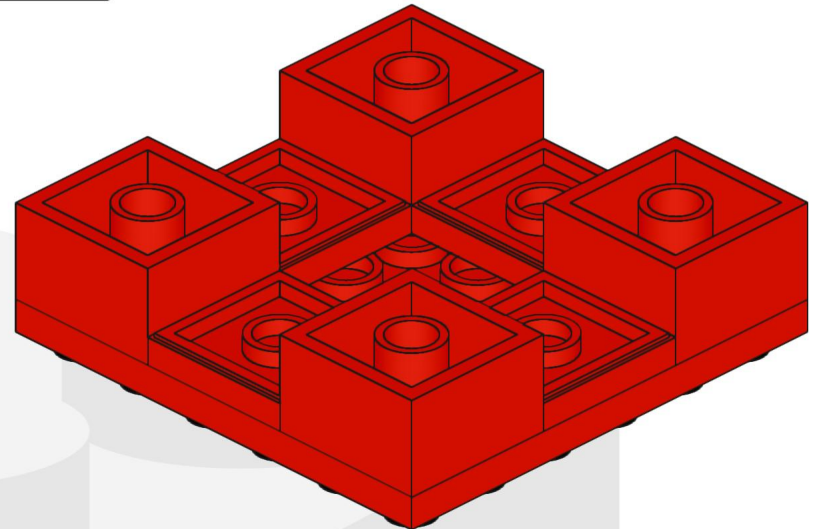
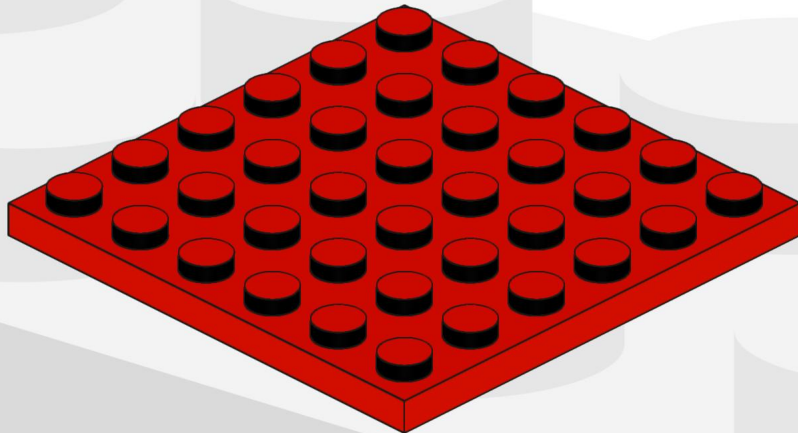
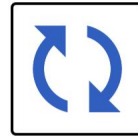
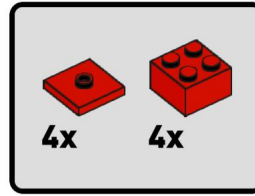

3

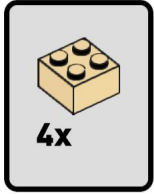

4

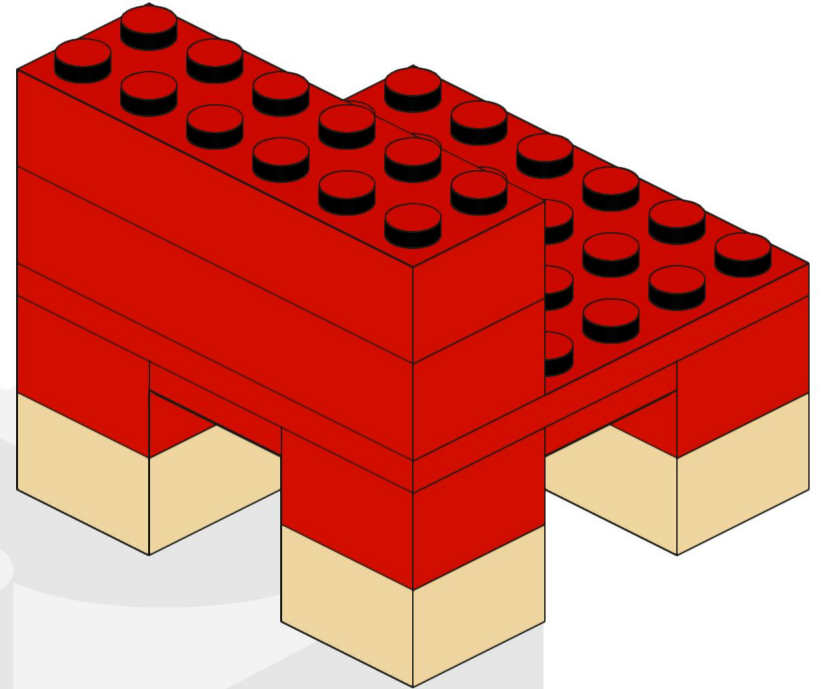
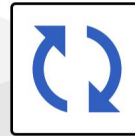
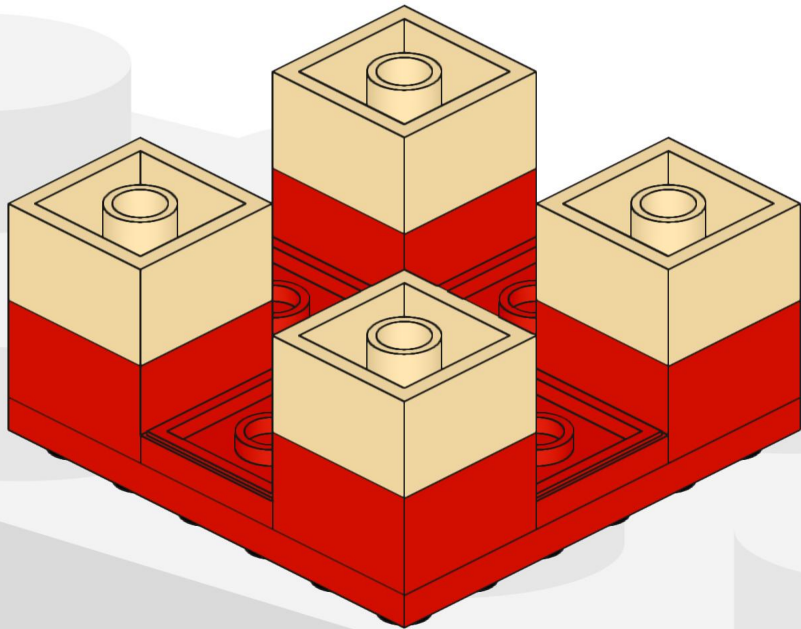
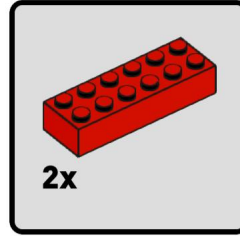

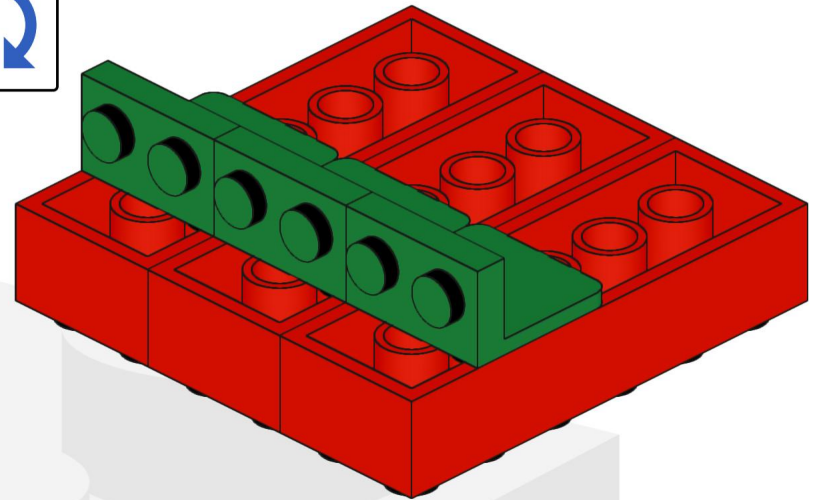
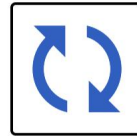
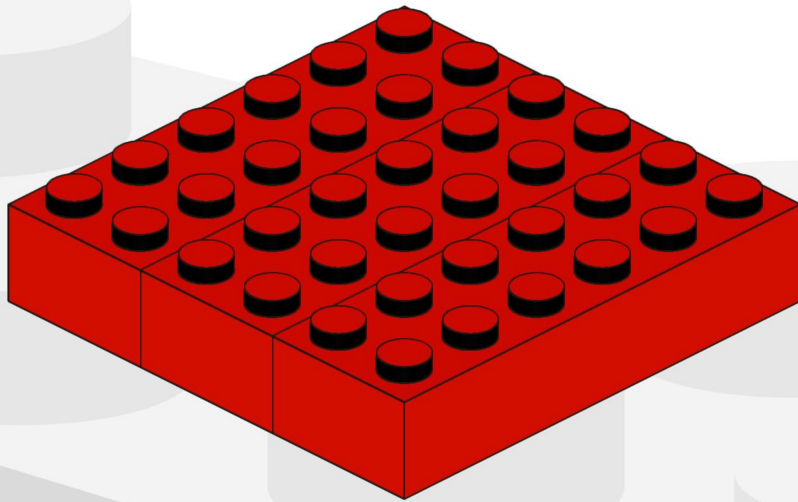
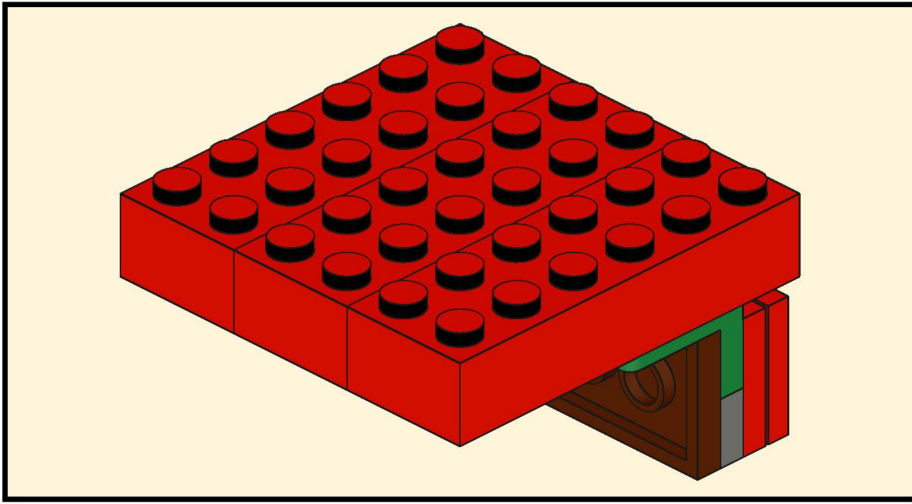

5

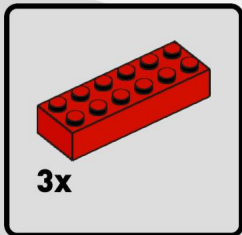

6

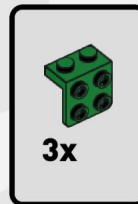

7

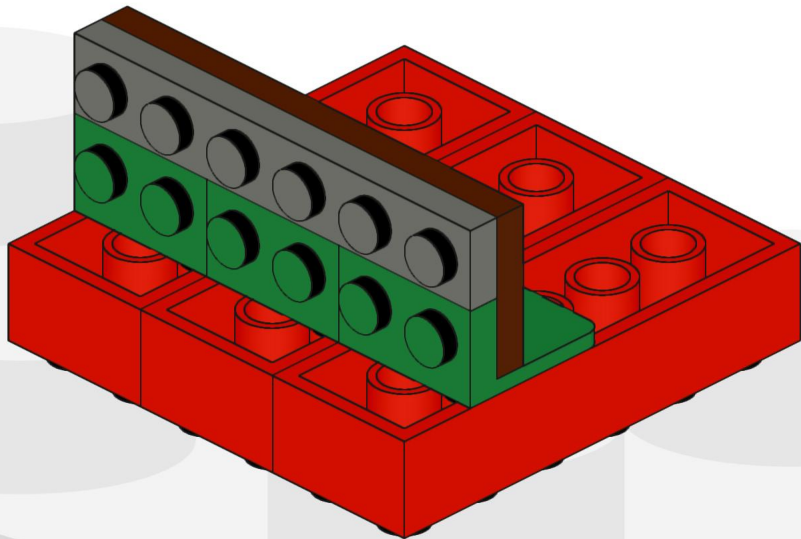
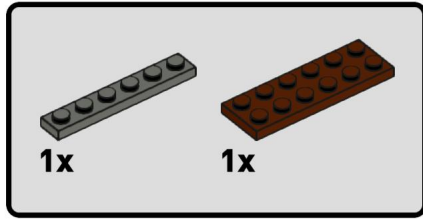

8

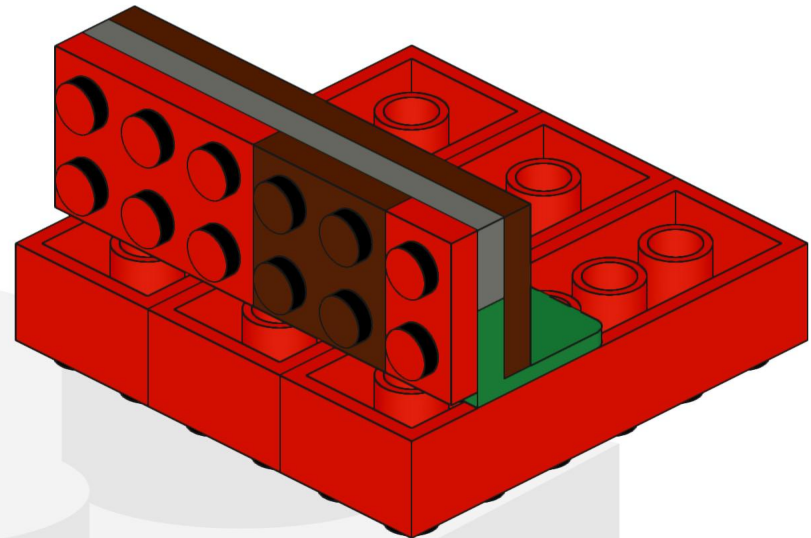
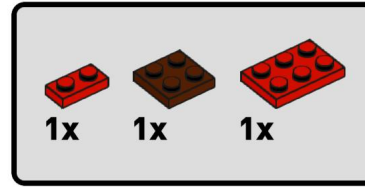

9

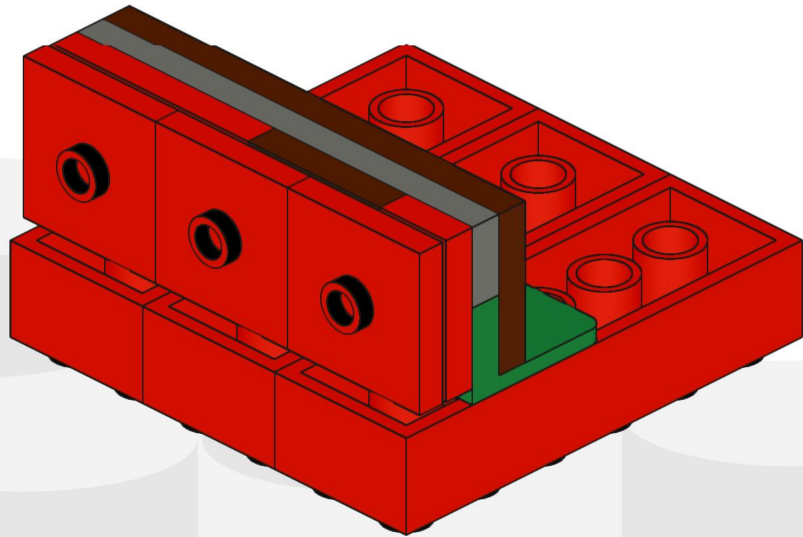
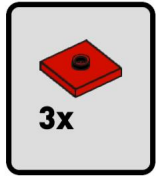

10

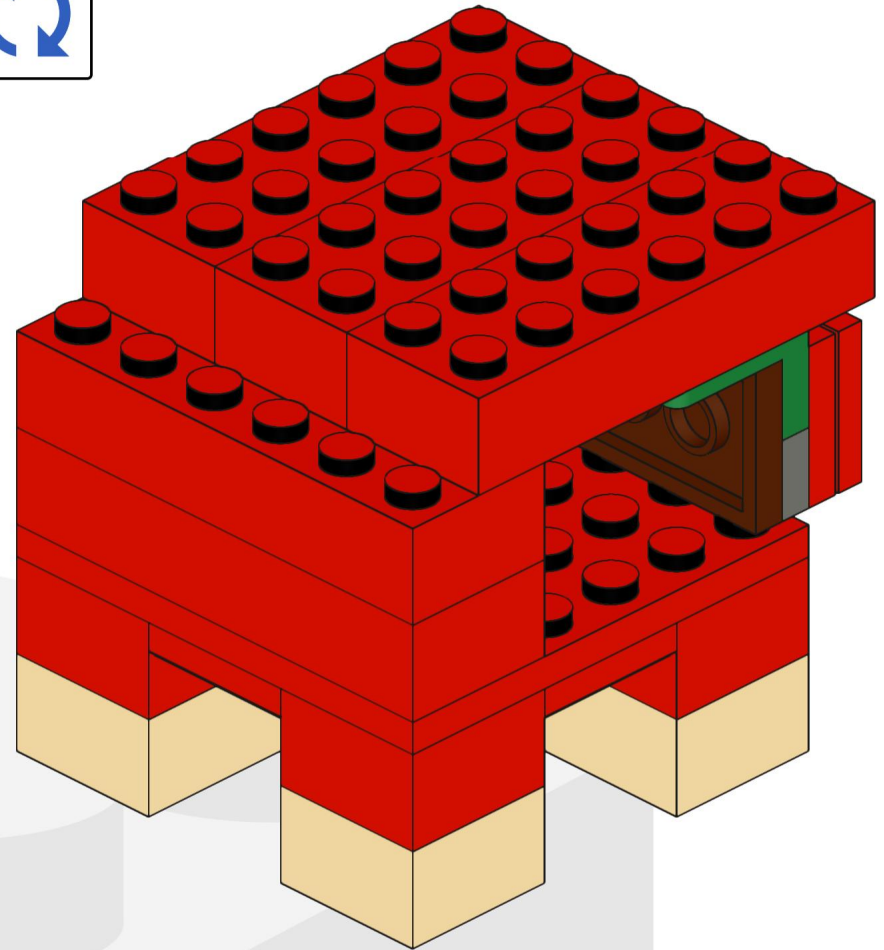
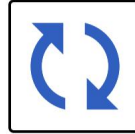

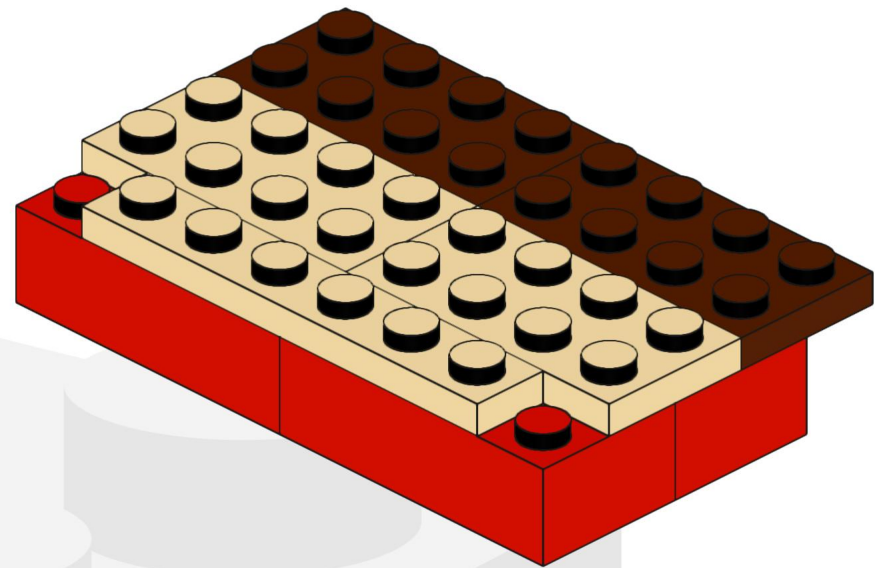
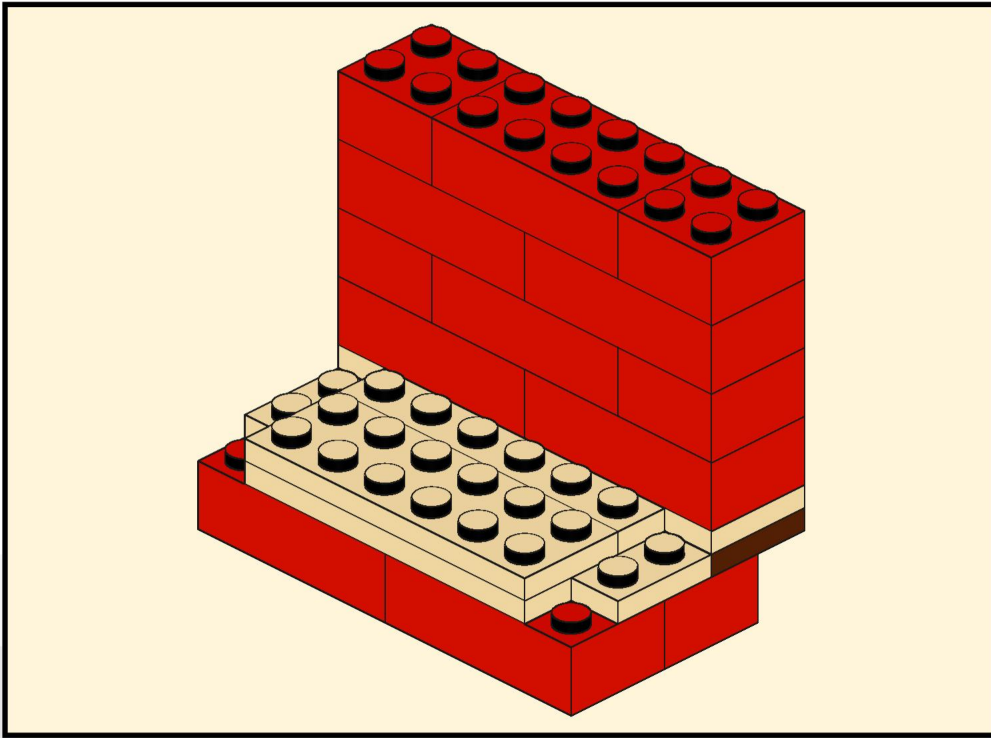

11

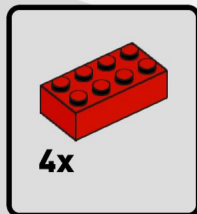

12

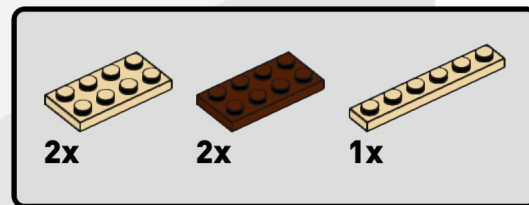

13

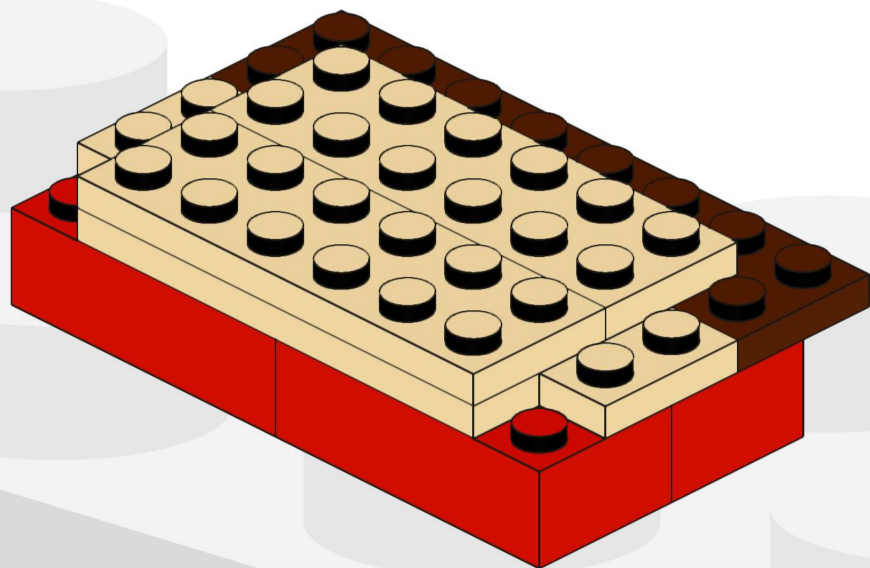
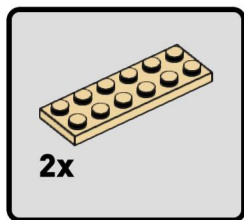

14

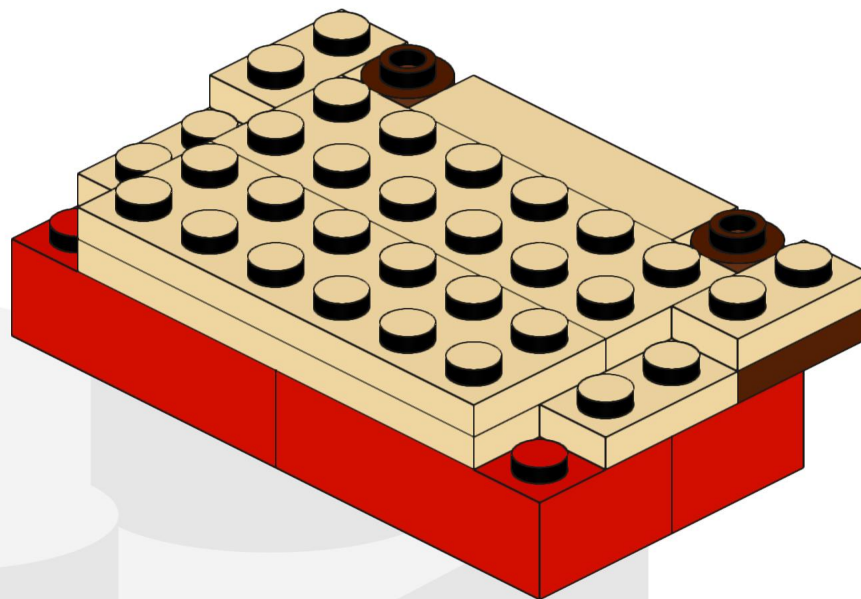
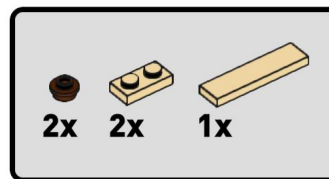

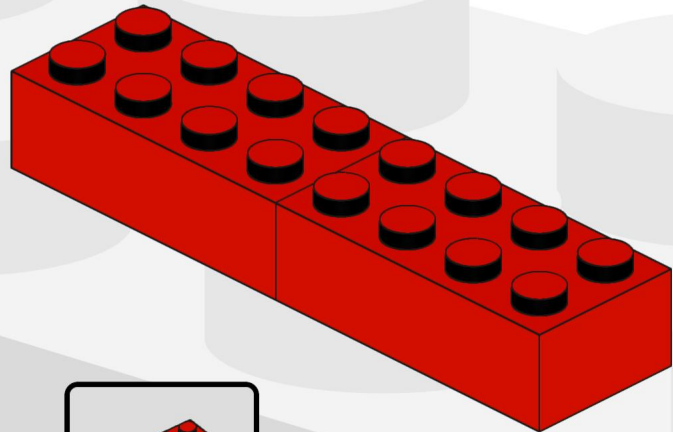
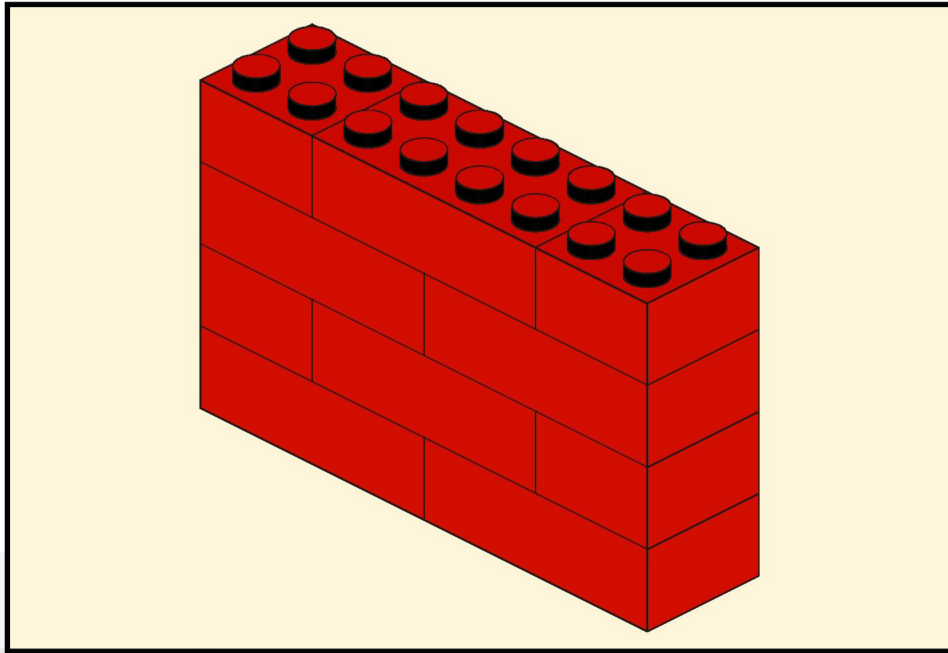

15

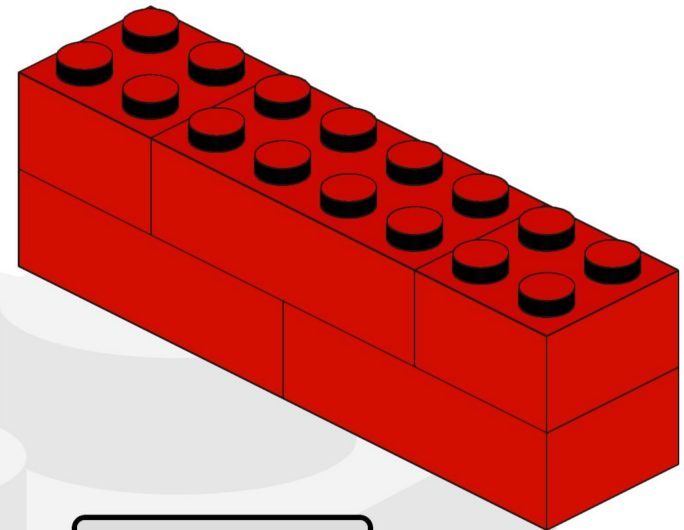
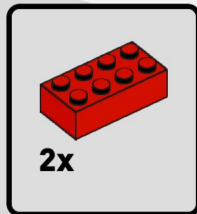

16

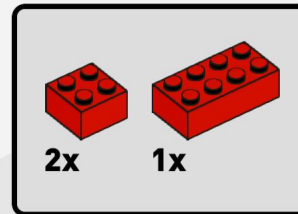

17

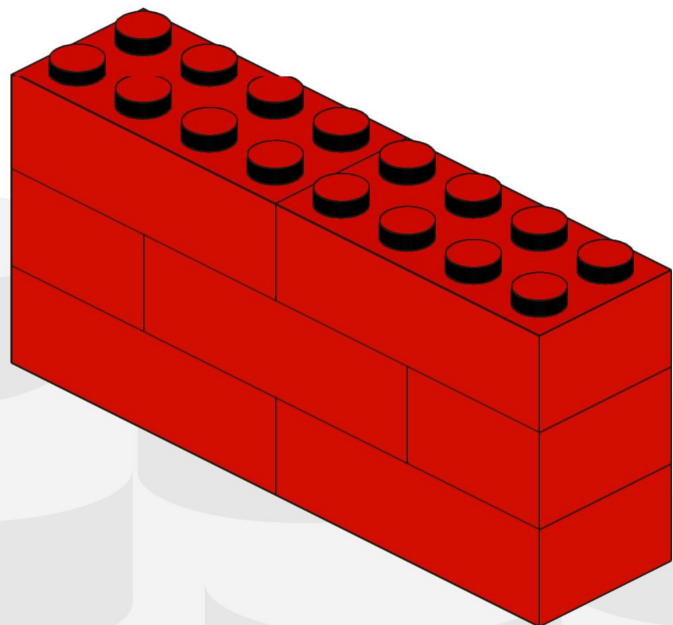
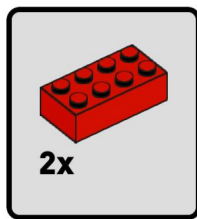

18

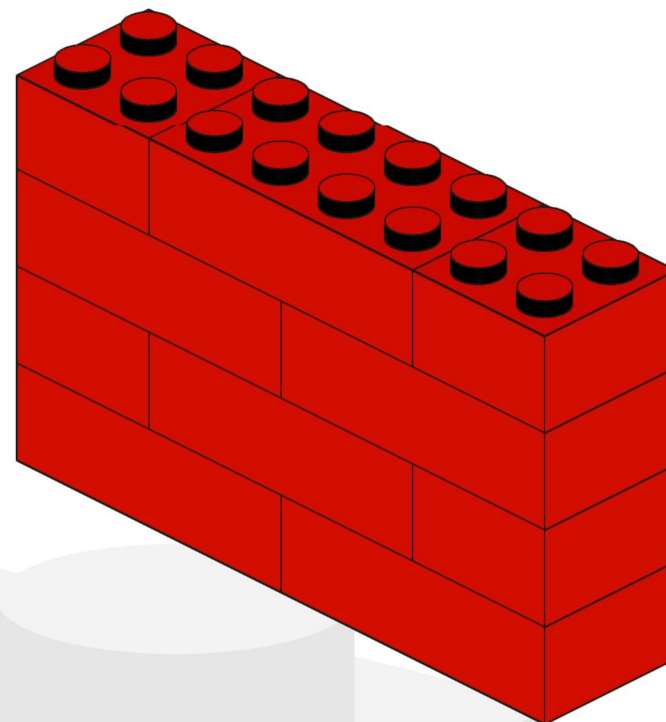
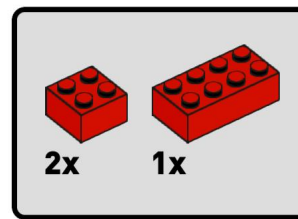

19

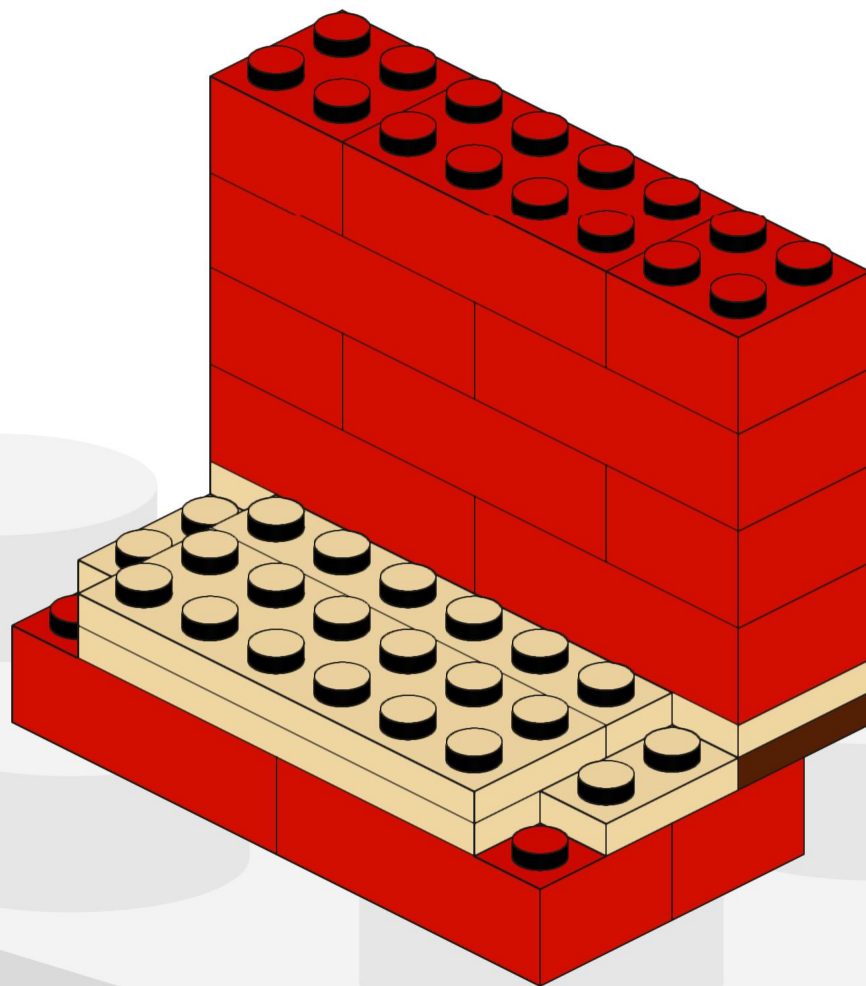

20

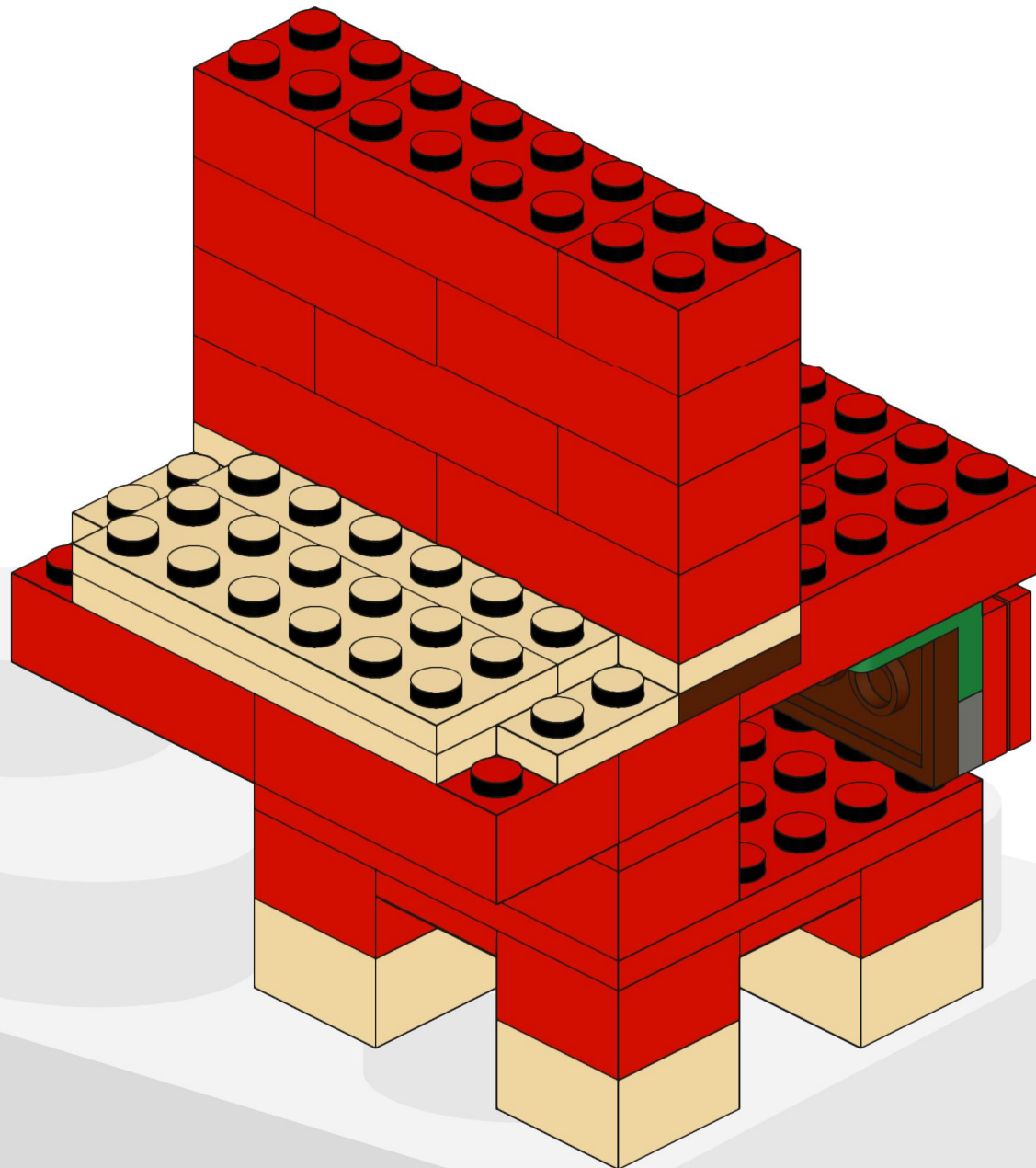

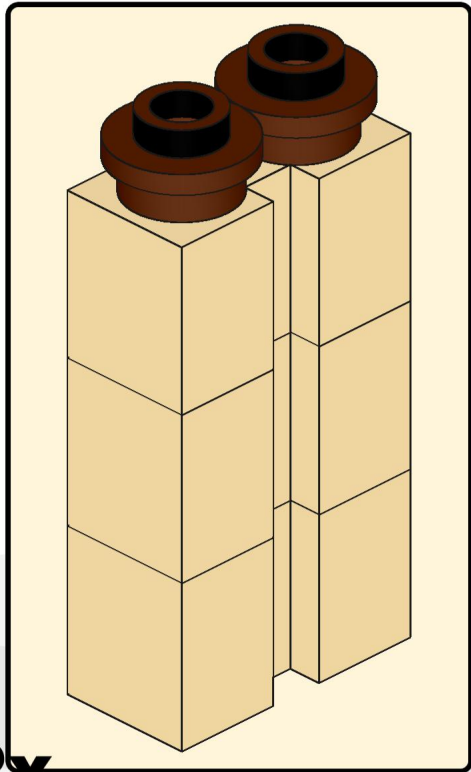

2x

21

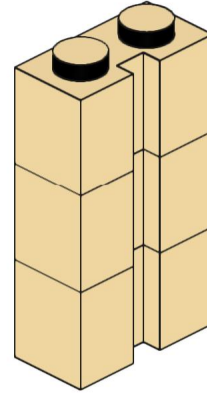
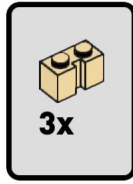

22

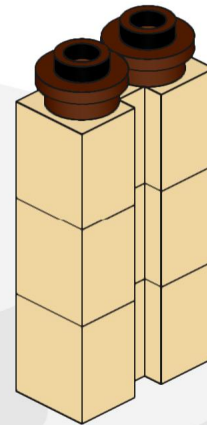

23

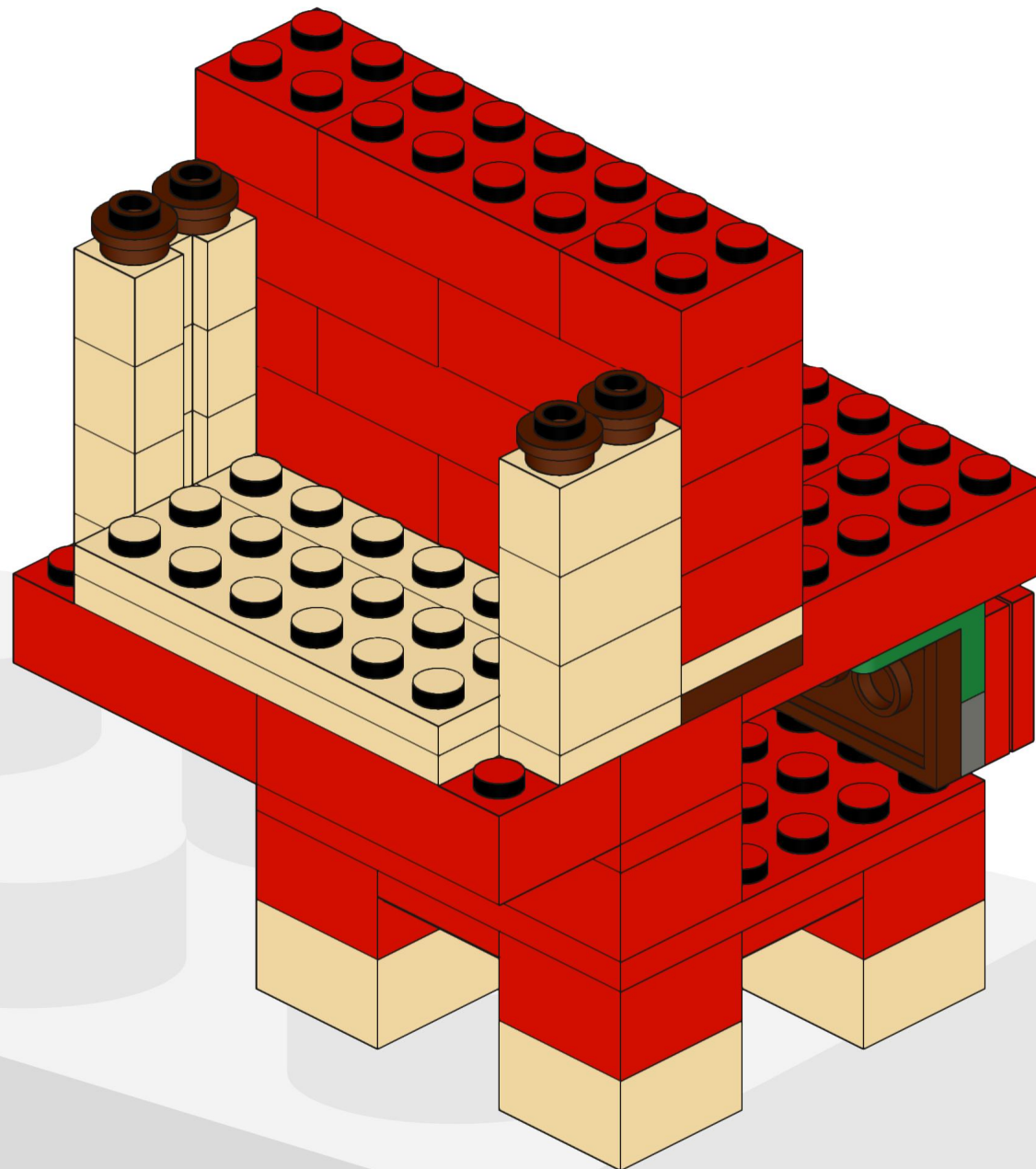

24

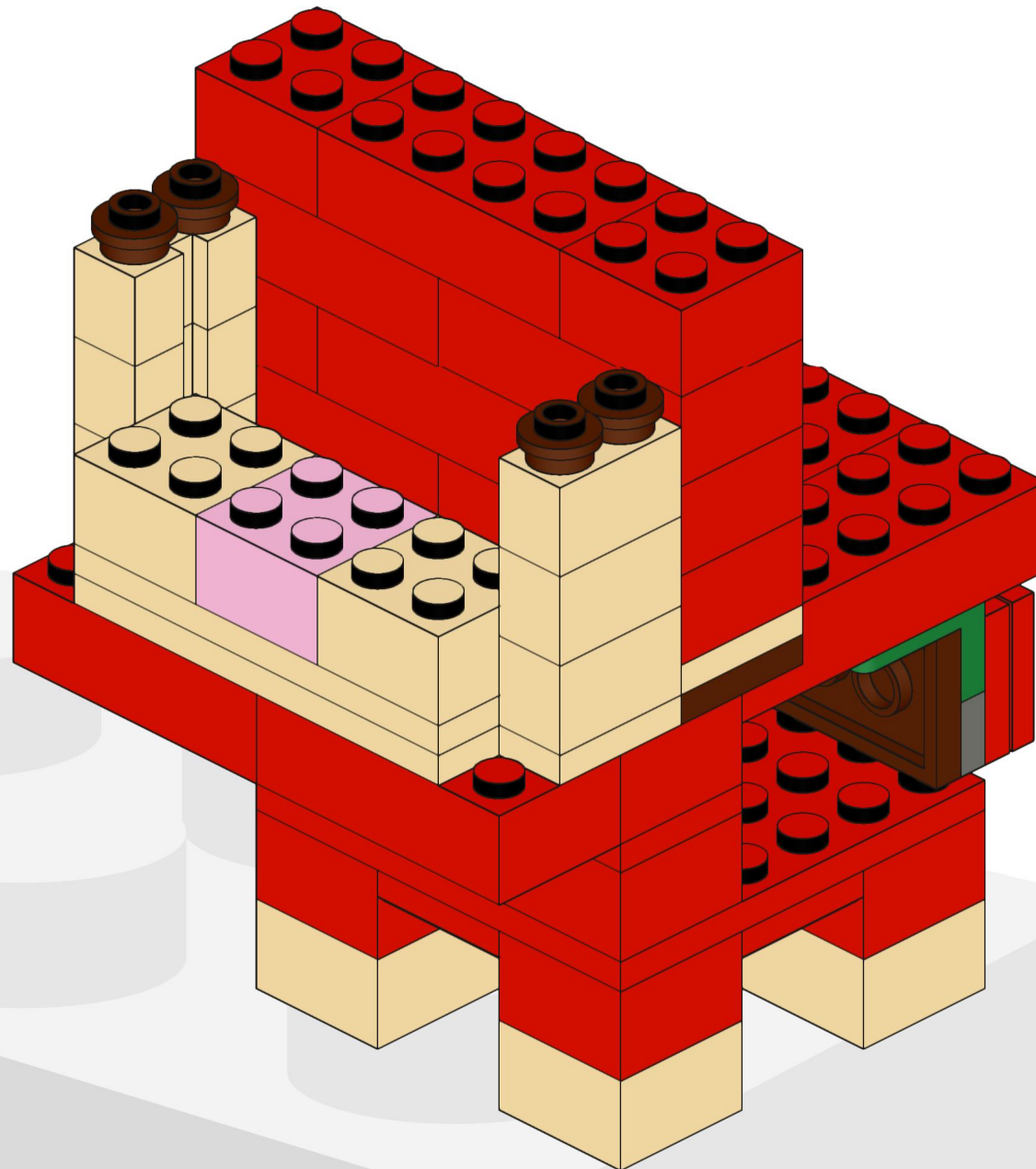
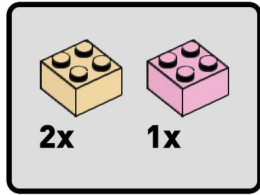

25

